

# 2025 HOMER NEW LIST PRODUCTS



**NEW**

**INSPECTION PORT PLASTIC** (white color)  
inside with sealing rubber O-ring  
clear cover made of polycarbonate

ITEM NO.    Φ  
**B24-020** 152mm(6")



**NEW**

**INSPECTION PORT STAINLESS  
FRAME WITH CLEAR COVER**

inside with sealing rubber O-ring  
clear cover made of polycarbonate  
stainless frame is AISI 316

ITEM NO.    Φ  
**B24-022** 152mm(6")



**NEW**

**LIFE BUOY BRACKET** stamped AISI 304

ITEM NO.	LxW mm	Thickness	Weight/g
<b>B24-001</b>	210x40	2 mm	210



**NEW**

**EYEBOLTS AND RINGS**

towing/lifting rings AISI 316

ITEM NO.	L mm	H mm	W mm	Mounting with
<b>B24-006</b>	38	35	15.6	M5 thread



**NEW**

**PULL DRAIN PLUGS AND SLEEVES**

ITEM NO.	Drainage hole	Weight/g
<b>B24-013</b>	32mm(1-1/4") AISI 316	50



**NEW**

**GARBOARD DRAIN PLUG** casted AISI 316

Thread, removeable plug highly polished.

ITEM NO.	L mm	L1 mm	B mm	Weight/g
<b>B17-002</b>	54	24	12	90



**FLAG POLE** stainless steel AISI 316

ITEM NO.	Length mm	Φ mm
<b>B24-003</b>	600(23-1/2")	19



**FLAG POLE WITH BASE MENT 45° AISI 316**

Staffs come completely with stainless steel  
the pole of sockets is 60cm(23-1/2")  
the basement:85mmx40mm(3-3/8"x1-9/16")

ITEM NO.	Weight/g
<b>B24-005</b>	580

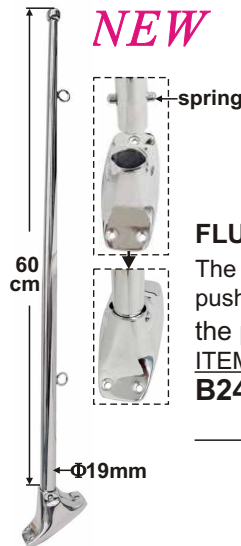

**FLUSH RECESSEL 45° AISI 316**

The flag pole can be fitted in the base by pushing the spring

the pole of socket is 60cm(23-1/2")

ITEM NO.	Base	Weight
<b>B24-028</b>	85mm x 42mm (3-3/8"x1-5/8")	520g



**30° DECK FILL & TANK VENT** casted AISI 316  
has a vent with a flame arrestor inte grated  
in the fill flange.

ITEM NO.	ΦDia mm	O.D. mm	Marking	Weight
<b>B24-016</b>	38(1-1/2")	82(3-3/16")	FULL	510g
<b>B24-017</b>	38(1-1/2")	82(3-3/16")	DIESEL	510g
<b>B24-018</b>	38(1-1/2")	82(3-3/16")	WATER	510g
<b>B24-019</b>	38(1-1/2")	82(3-3/16")	WASTE	510g



**FLUSH RECESSEL 10° AISI 316**

The flag pole can be fitted in the base by pushing the spring

the pole of socket is 60cm(23-1/2")

ITEM NO.	Base	Weight
<b>B24-029</b>	98mm x 28mm (38-1/2")x(1-1/8")	400g



**FLUSH MOUNT ROD HOLDER WITH BILGE EXIT** 90 degrees AISI 316 marine quality.  
Lined with white pvc to protect rod handle with plastic adapter, bilge exit connected to bilge exit a water pipe the water pipe can be put outside deck to keep the deck dry.

ITEM NO.	Φmm	L mm
<b>B24-008</b>	50	220



**FLUSH MOUNT ROD HOLDER WITH BILGE EXIT** 15 degrees AISI 316 marine quality.  
Lined with white pvc to protect rod handle with plastic adapter, bilge exit connected to bilge exit a water pipe the water pipe can be put outside deck to keep the deck dry.

ITEM NO.	Φmm	L mm
<b>B24-009</b>	50	220

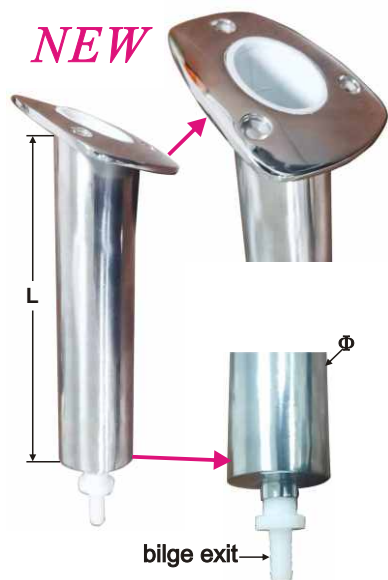

**FLUSH MOUNT ROD HOLDER WITH BILGE EXIT** 30 degrees AISI 316 marine quality. Lined with white pvc to protect rod handle with plastic adapter, bilge exit connected to bilge exit a water pipe the water pipe can be put outside deck to keep the deck dry.

ITEM NO.	Φ mm	L mm
<b>B24-004</b>	50	220



**FLUSH MOUNT ROD HOLDER WITH BILGE EXIT** 30 degrees AISI 316 marine quality. Lined with white pvc to protect rod handle with plastic adapter, bilge exit connected to bilge exit a water pipe the water pipe can be put outside deck to keep the deck dry.

ITEM NO.	Φ mm	L mm
<b>B24-010</b>	50	220



**FISHING ROD HOLDER** casted AISI 316  
Installation on rails  
Length:250mm(10") I.D.:50mm(2")

ITEM NO.	Rail pipe Φmm	Weight/g
<b>B24-023</b>	22(7/8")	760
<b>B24-024</b>	25(1")	770

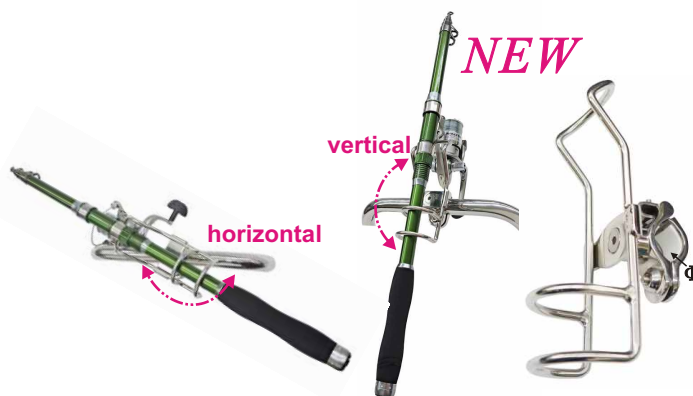

**ECONOMIC FISHING ROD HOLDER RACK** AISI 316  
Various angles can be adjusted.  
Like vertical or horizontal angle.

ITEM NO.	Rail pipe Φmm	Weight/g
<b>B24-011</b>	25	370
<b>B24-012</b>	22	360



**HOLDER FOR RESCUE DEVICE** AISI 304  
fit Φ22mm tube rail

ITEM NO.	Size	Weight/g
<b>B24-026</b>	Φ110mmx240mm	250



**STRUT HOLDER** AISI 316

ITEM NO.	Φ mm	Φ1 mm	H mm
<b>B24-002</b>	73(2-13/16")	38(1-1/2")	70(2-3/4")

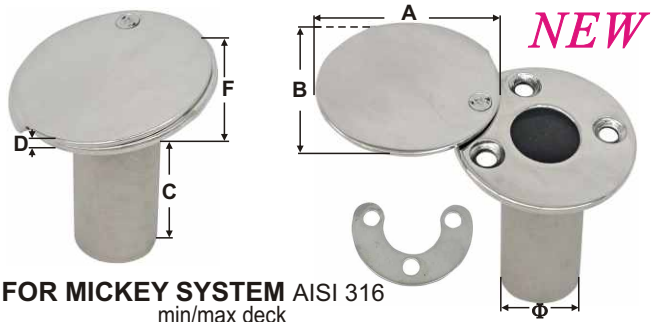

**STAINLESS STEEL FASTENING BUSHING FOR MICKEY SYSTEM** AISI 316  
 Bushing with fastening counter-ring. min/max deck

ITEM NO.	Description	For poles $\Phi$	Amm	Bmm	Cmm	Dmm	Emm	thickness Fmm	Weight/g
<b>B24-030</b>	No lid	16mm	56	56	54	5	26	8/40	190



**STAINLESS STEEL FASTENING BUSHING FOR MICKEY SYSTEM** AISI 316  
 Bushing with fastening counter-ring. min/max deck

ITEM NO.	Description	For poles $\Phi$	Amm	Bmm	Cmm	Dmm	$\Phi$ mm	thickness Fmm	Weight/g
<b>B24-031</b>	Rotary lid	16mm	69	61	50	9	26	2/50	240



**STAINLESS STEEL FASTENING BUSHING FOR MICKEY SYSTEM** AISI 316  
 Bushing with fastening counter-ring. min/max deck

ITEM NO.	Description	For poles $\Phi$	Amm	Bmm	Cmm	Dmm	$\Phi$ mm	thickness Fmm	Weight/g
<b>B24-032</b>	No lid	16mm	39	52	82	5	26	8/40	320



**STARLINK ADAPTER AND RATCHET BASE** casted AISI 316

Starlink 316 stainless steel adapter to mount to a 1"-14 thread  
 Bottom of the adapter has 1"-14 threads and comes with locking nut  
 Top of the adapter is machined to fit the starlink antenna post  
 The overall height is 19cm (adapter with the ratchet base)  
 Base measures 65mm(2-1/2")x92mm(3-9/16") with 4 holes for 1/4" bolts with 3/8" hole for cable pass through

ITEM NO. **B24-027**

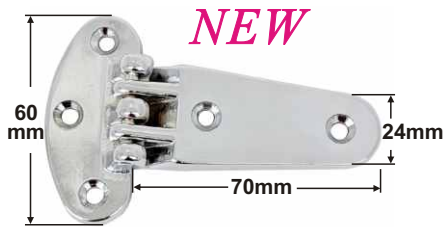

**HATCH HINGE** AISI 316  
 ITEM NO. stop mm Weight/g  
**B24-037** 8 78



**HATCH HINGE** AISI 316  
 Good for hatch opening  
 ITEM NO. Length Weight/g  
**B24-039** 110 mm 150



**HASP & STAPLE**  
 Made of AISI 316  
 The padlock ring can swivel and fold and fitted with padlock ring.  
 It's aligned and doesn't disturb when is set on top. universal studmounting.  
 Weight:100g  
 ITEM NO. **B24-040**



**PIPE FIT PLASTIC CLIP**  
 For attaching the fender basket on search land or pulpit to pipe with Φ22~25  
 Consumption:2-3 brackets for 2-3 baskets, depending on installation  
 ITEM NO. **B24-038**

ITEM NO.	PAGE
B17-002	N1
B24-001	N1
B24-002	N3
B24-003	N1
B24-004	N3
B24-005	N2
B24-006	N1
B24-008	N2
B24-009	N2
B24-010	N3
B24-011	N3
B24-012	N3
B24-013	N1
B24-016	N2
B24-017	N2
B24-018	N2
B24-019	N2
B24-020	N1
B24-022	N1
B24-023	N3
B24-024	N3
B24-026	N3
B24-027	N4
B24-028	N2
B24-029	N2
B24-030	N4
B24-031	N4
B24-032	N4
B24-037	N5
B24-038	N5
B24-039	N5
B24-040	N5



# 2024 HOMER NEW LIST PRODUCTS

**NEW**



**TORPEDO-CLEAT** casted AISI 316  
Cleat in streamlined design, delivery including 2 fixing bolts  
ITEM NO. L mm L1 mm Bolt mm Weight/g  
**B23-048** 100 30 6

**NEW**



**NO SOUND PULL OUT CLEATS** casted AISI 316  
ITEM NO. Length mm Thread Weight/g  
**B23-036** 155(6-1/8") M10 540

**NEW**



**POP-UP MINI CLEATS** casted AISI 316 for small boats.  
ITEM NO. Base mm Hole mm Weight/g  
**003871** 89x31 22 260  
**003874** 130x39 34 410

**NEW**



**DOOR CLAMPS** casted AISI 316  
Two versions  
ITEM NO. **B23-050**



**DECK FILL WITH KEY** casted AISI 316  
ITEM NO. O.D. mm Dia mm Marking Weight/g  
**008893** 90 50(2") GAS 690  
**008894** 90 50(2") DIESEL 690  
**008895** 90 50(2") FUEL 690



**FRONT HATCH FITTING** casted AISI 316  
In heavy design bolt diameter:8mm  
ITEM NO. Length weight/g  
**B23-051** 60mm  
**B23-052** 105mm

**NEW**



**SINGLE LEAD BLOCK** AISI 304  
For rope  $\Phi$ 8mm  
plastic sheaves 30x11mm  
ITEM NO. Weight/g  
**B23-049** 31

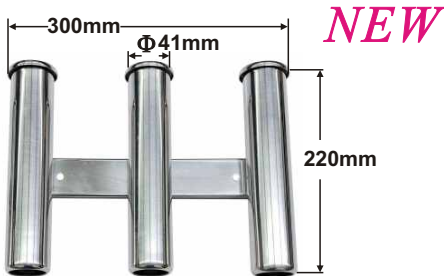

**ROD HOLDER FOR 3 FISHING ROD**  
Made of stainless steel tube AISI 304  
ITEM NO. Length  
**B23-053** 300mm

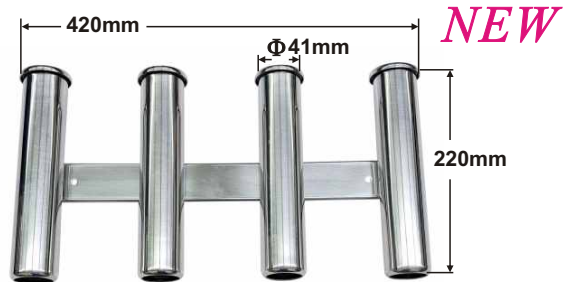

**ROD HOLDER FOR 4 FISHING ROD**  
Made of stainless steel tube AISI 304  
ITEM NO. Length  
**B23-054** 420mm



**SWIVELING TRIPLE COAT HOOK** AISI 316  
 ITEM NO. D mm D1 mm H mm W mm Weight/g  
**B23-025** 50 65 57 25 100

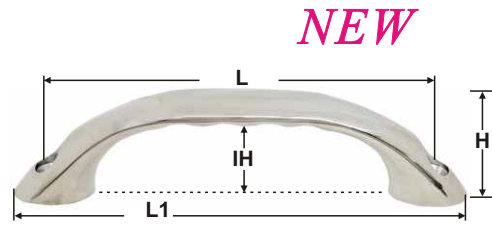

**HANDLE** AISI 316  
 ITEM NO. L mm L1 mm IH mm H mm Weight/g  
**B23-026** 141 170 32 40 230



**FLUSH LIFTING HANDLE** precision casted AISI 316  
 ITEM NO. LXW Handle Thickness Weight/g  
**B23-031** 75x59mm 58x33mm 2.5mm 180  
 (3"x2-5/16") (2-5/16"x1-5/8")

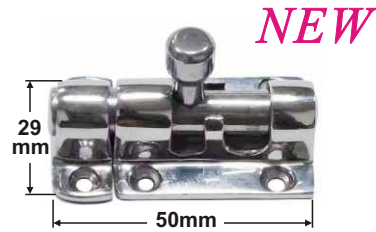

**STAINLESS BARREL BOLTS**  
 precision casted AISI 316  
 ITEM NO. Overall  
**B23-029** 50mmx29mm

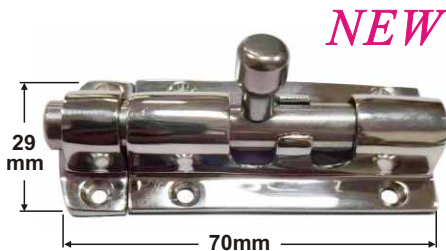

**STAINLESS BARREL BOLTS**  
 precision casted AISI 316  
 ITEM NO. Overall  
**B23-030** 70mmx29mm



**FENDER HOOK WITH SAFTY SNAP** AISI 316  
 ITEM NO. **B23-009**



**SAFE SNAP** AISI 316  
 Stainless steel,  
 It is good for sail boat  
 ITEM NO. **2431-SS**



**INSPECTION PORT ADJUSTABLE KEY** AISI 304  
 Stainless steel  
 Flexible wire you can use one key for  
 all kind of inspection ports which is the advantage.  
 ITEM NO. **B22-001**





**NEW**

**HANDRAIL END FITTING/  
EMBOU MAIN COURANTE**

casted AISI 316

ITEM NO.	Φmm	L mm	Weight/g
<b>B23-004</b>	25	65	160



**NEW**

**HANDRAIL CENTER FITTING/  
PASSAGE MAIN COURANTE**

casted AISI 316

ITEM NO.	Φmm	L mm	Weight/g
<b>B23-005</b>	25	65	90



**NEW**

**TOP SLIDE WITH NUT** casted AISI 316

Ideal for installing bimini tops stringers for fender racks or wherever a rail mounted hinge is commonly needed

ITEM NO. Tube O.D.

<b>B23-002</b>	22mm(7/8")
<b>B23-003</b>	25mm(1")



**NEW**

**SNEATCH CLEAT/  
SNATCH PLATE** AISI 316

ITEM NO. **B23-006**



**NEW**

**RAIL MOUNT FLAG POLE SOCKET**

casted AISI 316

ITEM NO.	for tube-Φ	L	L1
<b>B22-004</b>	25mm	20mm	40mm



**NEW**

**SPINNAKER POLE HOLDER** AISI 304

for Φ25mm tube Ring Φ65mm

ITEM NO.	Weight/g
<b>B23-035</b>	86

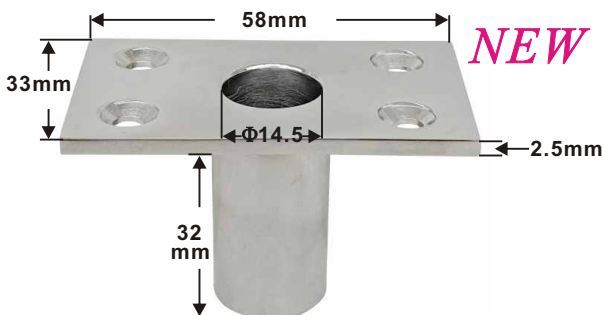

**NEW**

**FLUSH MOUNT POLE SOCKETS** AISI 316

Vertical sockets are typically used on the bow

ITEM NO.	I.D.	Weight/g
<b>B23-007</b>	14.5mm	55



**NEW**

**NEW ANTENNA RATCHET  
MOUNTS** casted AISI 316

Thread 1"-14

ITEM NO. **B22-019**



**NEW**

**STAINLESS STEEL EXTENSIONS**

For metal GPS bases.

ITEM NO.	Tube Φ	Threaded	H mm	Weight/g
<b>B23-008</b>	32mm	1"	100	208

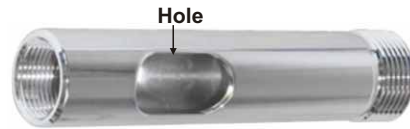

**NEW**

**STAINLESS STEEL EXTENSIONS WITH HOLE**

For metal GPS bases.

ITEM NO.	Tube Φ	Threaded	H mm	Weight/g
<b>B23-055</b>	32mm	1"	100	208



**NEW**

←stainless steel

**FASTENING SET FOR SUPS**

With the attachment kit you can easily attach your SUP to the board ! 360 adjustable clamps made of high-strength nylon material with high degree of flexibility.

Suitable for pipes dia. 22 to 30mm

Snap closure length: 180cm

ITEM NO. **B23-032**

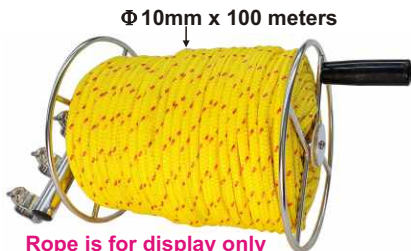

Rope is for display only  
The product is not including rope



**NEW**

**REEL FOR SAFETY LINE** AISI 304

with approx 100 meters cord dia 10mm for recure-body vertical mount

Roll over all 200mm

Width 450mm

ITEM NO. Weight/g

**B23-027** 1800



**NEW**

**BUTTERFLY VENT**

stamped AISI 304

ITEM NO. Φ mm

**B23-041** 180



**NEW**

**VENT WITH THREAD** casted AISI 316

Heavy duty

ITEM NO. Lmm x Wmm Thread Weight/g

**B23-034** 127(5-1/16")x127(5-1/16") M6 400



**NEW**

**BERLEY CHOPPER**

stainless steel

ITEM NO. **B23-012**

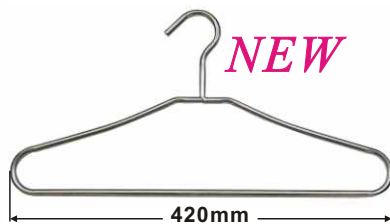

**NEW**

**CLOTH HANGER**

stainless steel tube

ITEM NO. **B23-045**



**NEW**

**LIVE BAIT WATERSCOOP**

T/S PUMP stainless steel

ITEM NO. **B23-013**



**NEW**

**LIVE BAIT WATERSCOOP**

stainless steel

ITEM NO. **B23-014**



**NEW**

**FENDER STRIP** AISI 316  
To mount on support PVC UV bases  
ITEM NO. **B23-010**

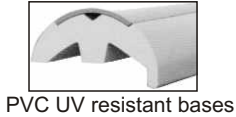

**NEW**

**FENDER STRIP** AISI 316  
To mount on support PVC UV bases  
ITEM NO. **B23-011**

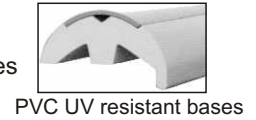

**NEW**

**FENDER STRIP** AISI 316  
To mount on support PVC UV bases  
ITEM NO. **B23-020**



**NEW**

**FENDER STRIP** AISI 316  
To mount on support PVC UV bases  
ITEM NO. **B23-021**

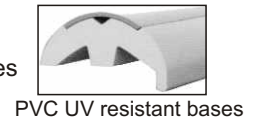

**NEW**

**FENDER STRIP** AISI 316  
To mount on support PVC UV bases  
ITEM NO. **B23-022**

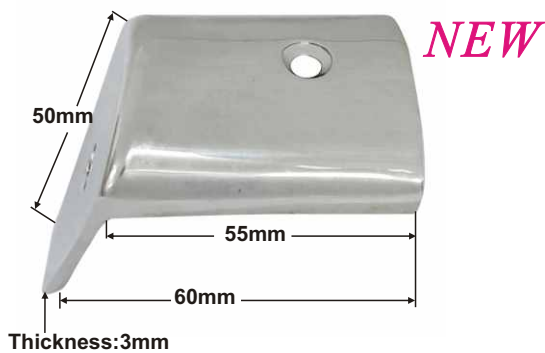

**NEW**

**FENDER STRIP** AISI 316  
To mount on support PVC UV bases  
ITEM NO. **B23-024**

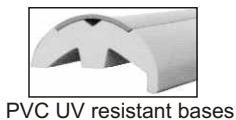

**NEW**

**FENDER STRIP** AISI 316  
To mount on support PVC UV bases  
ITEM NO. **B23-023**

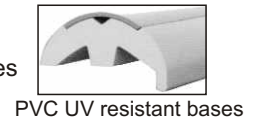

# 2023 NEW PRODUCTS



**FENDER HALTER MIT DREHVERSCHLUSS** AISI 316

Swivel fender holder

ITEM NO.	L mm	L1 mm	H mm	W mm	weight/g
----------	------	-------	------	------	----------

<b>B22-005</b>	63	18	27	25	120
----------------	----	----	----	----	-----



**FOLDABLE PAD EYE** AISI 316

ITEM NO.	L mm	H mm	W mm	weight/g
----------	------	------	------	----------

<b>B22-006</b>	70	55	60	150
----------------	----	----	----	-----



**INSPECTION PORT** casted AISI 316

ITEM NO.	I.D. mm	Flange O.Dmm	Cut out Hole size mm	Weight/g
----------	------------	-----------------	-------------------------	----------

<b>B22-007</b>	75(3")	119(4-11/16")	85(3-3/8")	479
----------------	--------	---------------	------------	-----

<b>B22-008</b>	100(4")	141(5-9/16")	111(4-3/8")	753
----------------	---------	--------------	-------------	-----



**DOOR STOP AND CATCHER**

casted AISI 316

ITEM NO.	Weight/g
----------	----------

<b>B22-009</b>	202
----------------	-----

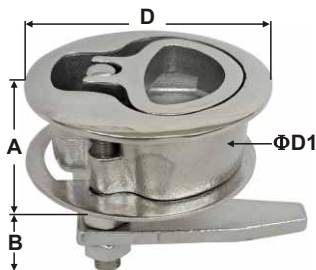

**LIFTING HANDLE** AISI 316

ITEM NO.	D mm	D1 mm	A mm	B mm	weight/g
----------	------	-------	------	------	----------

<b>B22-010</b>	61	51	21	39	280
----------------	----	----	----	----	-----

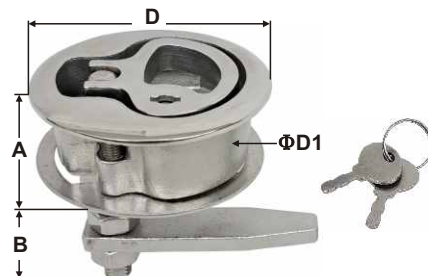

**LIFTING HANDLE WITH KEY** AISI 316

ITEM NO.	D mm	D1 mm	A mm	B mm	weight/g
----------	------	-------	------	------	----------

<b>B22-011</b>	61	51	21	39	280
----------------	----	----	----	----	-----

# 2021 NEW PRODUCTS

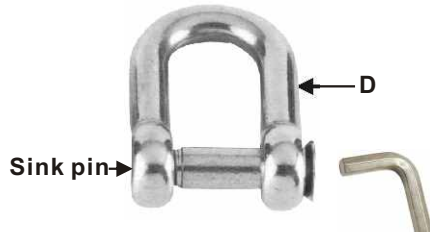

**D SHACKLE WITH OVAL SINK PIN** AISI 316

ITEM NO.	D mm	BL/KG	Weight/g
<b>003406</b>	6(1/4")	1800	22
<b>003408</b>	8(1/3")	3500	45
<b>003410</b>	10(2/5")	5400	100



**BOW SHACKLES WITH OVAL SINK PIN** AISI 316

ITEM NO.	D	B	R	d	L	BL/KG	Weight/g
	mm	mm	mm	mm	mm		
<b>001306-P</b>	6(1/4")	12	21	12	24	1500	29
<b>001308-P</b>	8(5/16")	16	28	16	32	2300	73
<b>001310-P</b>	10(13/32")	20	34	20	40	3700	136

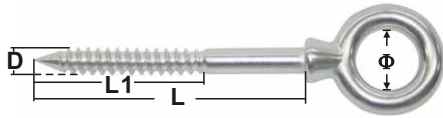

**SCREW EYES** AISI 316  
Eye with screw thread is ideal for balustrade ends into wooden poles and for other applications

ITEM NO.	D	L mm	L1 mm	Φ mm
<b>001800</b>	5	50	30	11
<b>001801</b>	6	60	35	14
<b>001802</b>	8	80	50	18
<b>001803</b>	10	100	60	22



**WOOD SCREW EYE RING** AISI 316

ITEM NO.	D	D1	L mm	L1 mm	Φ mm
<b>001816</b>	5	6	50	30	35
<b>001817</b>	6	6	60	35	35
<b>001818</b>	8	8	80	50	45
<b>001819</b>	10	8	100	60	50



**SAFETY JAW AND JAW SWIVEL** AISI 316

ITEM NO.	Size	L	B	C	D	BL/KG	Weight/g
		mm	mm	mm	mm		
<b>000317</b>	6	66	12	11	6	1350	61
<b>000318</b>	8	94	16	16	8	2500	160
<b>000319</b>	10	118	20	22	10	3500	320

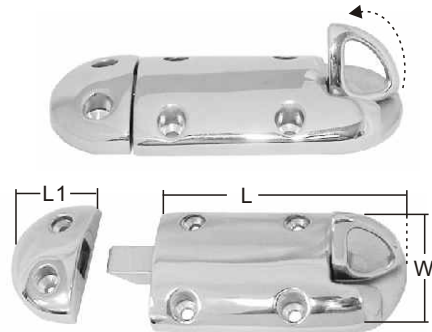

**LOCKING DEVICE WITH SPRING LOADED BOLT** casted AISI 316

ITEM NO.	L mm	L1 mm	W mm	Weight/g
<b>008399</b>	100	35	52	282

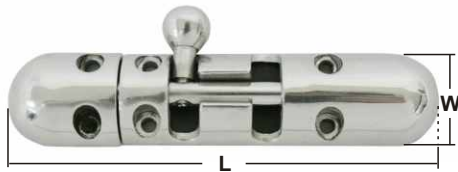

**SLIM BARREL BOLT** casted AISI 316  
Visible mounting holes integral friction pad eliminates rattle and provides smooth operation.

ITEM NO.	Lmm	Wmm	Weight/g
<b>008319</b>	88	18	60



**SLIM BARREL BOLT** casted AISI 316  
Visible mounting holes integral friction pad eliminates rattle and provides smooth operation.

ITEM NO.	Lmm	Wmm	Weight/g
<b>008311</b>	88	18	60



**HOMER MFG & CO., LTD.**  
**P.O. BOX 22-23, TAICHUNG, TAIWAN**

360, SEC.1 SHIN LIN RD. TA YA HSIANG TAICHUNG HSIEN TAIWAN  
TEL:886-4-25661433.25661494.25673955 FAX:886-4-25672783  
E-mail:info@homer-bh.com.tw  
Website:http://www.homer-bh.com.tw



**90° BARREL BOLTS** precision casted AISI 316  
 ITEM NO. Overall mm Weight  
**008340** 55x39(2-3/16"x1-1/2") 100g



**ECCENTRIC LATCH WITH PADLOCK**  
 EYE stamped AISI 304  
 ITEM NO. Total length Width Travel Weight/g  
**008348** 82mm 20mm 4.5mm 60

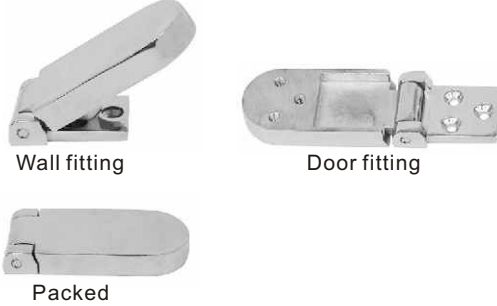

**HEAVY DUTY HINGE** casted AISI 316  
 Packed Wall fitting Door fitting  
 ITEM NO. mm mm mm Weight/g  
**008614** 45x30 25x30 20x30 92



**COVERS WITH HINGES** AISI 304  
 No visible screw, easy to clean  
 ITEM NO. **006137**



**COVERS WITH HINGES** AISI 304  
 No visible screw, easy to clean  
 ITEM NO. **006139**



**COVERS WITH HINGES** AISI 304  
 No visible screw, easy to clean  
 ITEM NO. **006138**

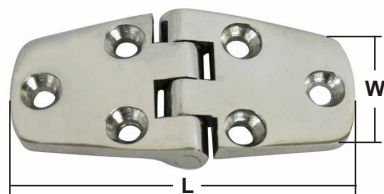

**DOOR HINGE** precision casted AISI 316  
 Reverse  
 ITEM NO. WxLmm Thickness Weight/g  
**008512** 38x75(1-1/2"x3") 4.5mm 89



**DOOR HINGE** precision casted AISI 316  
 ITEM NO. WxLmm Thickness Weight/g  
**008515** 80x100(3-3/16"x4") 4mm 300

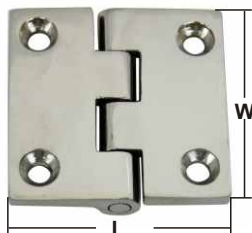

**DOOR HINGE** precision casted AISI 316  
 Reverse  
 ITEM NO. WxLmm Thickness Weight/g  
**008511** 50x50(2"x2") 4.5mm 89



**HINGE** stamped AISI 304  
 ITEM NO. Thickness Weight/g  
**B19-028** 2mm 70



**HINGE** casted AISI 316

ITEM NO.	L mm	B mm	Thickness	Weight/g
<b>B19-027</b>	85	18	4.5mm	120

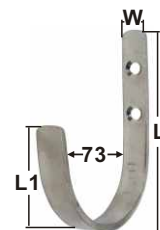

**BOAT HOOK HOLDER WITH LONG HOOK** AISI 304

ITEM NO.	L mm	L1 mm	W mm	Thickness
<b>B19-030</b>	105	65	15	4mm



**LIFT OFF HINGE** stamped AISI 304

ITEM NO.	Thickness	Weight
<b>008516</b>	2.0mm	40g

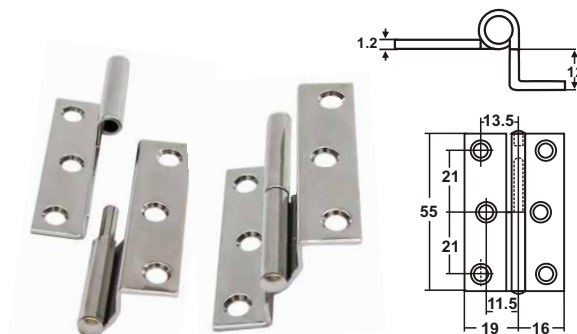

**LIFT OFF HINGE** stamped AISI 304

ITEM NO.	Note	Weight/g
<b>B18-015L</b>	Right handed	36
<b>B18-015R</b>	Left handed	36



**HINGE WITH PIN** stamped AISI 304

ITEM NO.	Thickness	Weight/g
<b>008514</b>	2mm	50

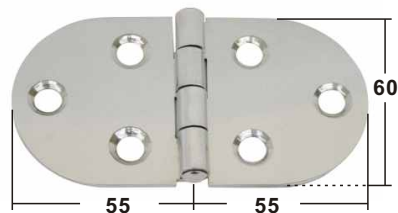

**HINGE** stamped AISI 304

ITEM NO.	Thickness	Weight/g
<b>008513</b>	2mm	95

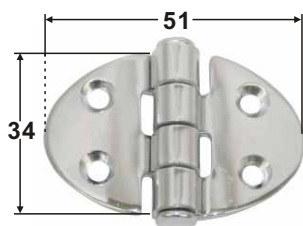

**HINGE** Stamped AISI 316

Buff polished

ITEM NO.	Thickness	Weight
<b>006134</b>	2mm	30g

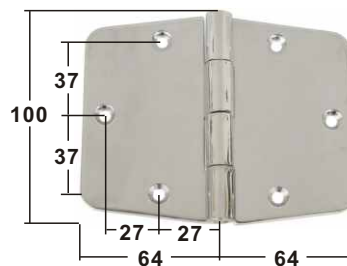

**HINGE** stamped AISI 316 buff polished

ITEM NO.	Thickness	Weight/g
<b>006132</b>	3mm	340

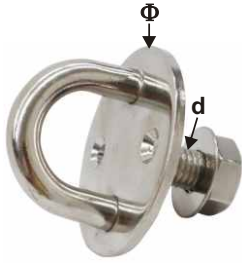

**EYE PLATE with WASHER & NUT**  
stamped AISI 304

ITEM NO.	$\Phi$ mm	Thickness	d mm	Weight/g
<b>003590</b>	33	2.5mm	M6	28
<b>003591</b>	40	2.5mm	M8	50
<b>003592</b>	50	3.0mm	M10	90



**ROUND EYE PLATE WITH  
THREAD AND RING** AISI 304

ITEM NO.	$\Phi$ mm	Thickness	d mm	Ring	Weight/g
<b>B19-024</b>	33	2.5mm	M6	5x30	40
<b>B19-025</b>	40	2.5mm	M8	6x35	70
<b>B19-026</b>	50	3.0mm	M10	8x45	140



**ROUND RING WITH PLATE** stamped AISI 304

ITEM NO.	L mm	B mm	Ring mm	Weight/g
<b>B19-039</b>	70	40	$\Phi$ 10x80	290



**ROUND PLATE HOOKS** stamped AISI 304

ITEM NO.	D mm	H mm	Thickness	Weight/g
<b>003695</b>	33	9	2.5mm	20
<b>003696</b>	40	9	2.5mm	40
<b>003697</b>	50	15	3.0mm	60

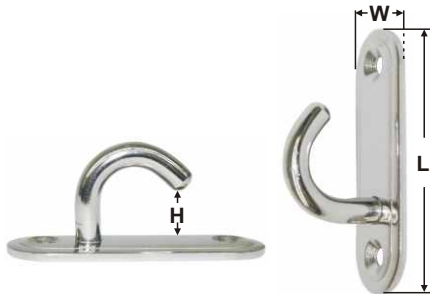

**PLATE HOOK** stamped AISI 304

ITEM NO.	L mm	W mm	H mm	Weight/g
<b>003597</b>	45(1-49/64")	15(5/8")	9	15
<b>003598</b>	60(2-23/64")	20(25/32")	13	30
<b>003599</b>	80(3-5/32")	25(1")	15	60



**EYE PLATE WITH FIXED RING**  
stamped AISI 304

ITEM NO.	L mm	B mm	Ring mm
<b>B18-013</b>	70	40	$\Phi$ 8x45



**HEAVY DUTY ROUND PAD EYES** AISI 316

ITEM NO.	Base	Inside	Ring	
	Dia	Dia	Dia	
<b>003693</b>	58mm	17mm	9.5mm	
	(2-1/4")	(11/16")	(3/8")	6000kg(13200Lb)



**DOUBLE FOLDING PAD EYE** AISI 316

ITEM NO.	Fold down when not in use double ring		Weight/g
	Ring	Breaking load	
<b>003692</b>	10mm	9000 kg	





**DECK PLATE WITH SWIVEL SNAP**

**SHACKLE** AISI 316

ITEM NO.	A mm	L mm	W mm	Weight/g
<b>003684</b>	16	75	28	110
<b>003688</b>	21	95	35	270



**3 BAR MOVEABLE HOOKS** casted AISI 316

ITEM NO.	L mm	W mm	Weight/g
<b>003129</b>	69(2-3/4")	38(1-1/2")	170

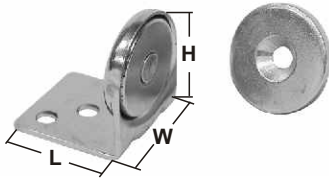

**MAGNETIC CLASPS** stamped AISI 304

For 3/4"(19mm) thick surfaces.

ITEM NO.	Dimensions	Capacity	Weight/g
<b>003687</b>	31mmL x 28mmW x 31mmH 1-1/4"(L) x 1-1/8"(W) x 1-1/4"(H)	18kg (40lb)	



Flush strike

**MAGNETIC DOOR & WINDOW HOLDER**

Casted AISI 316

ITEM NO.	Weight/g
<b>003698</b>	220



**DOOR STOP AND CATCHER 90°**

casted AISI 316

ITEM NO.	L mm	H mm	Φ mm	Weight/g
<b>B19-017</b>	92	52	50	180

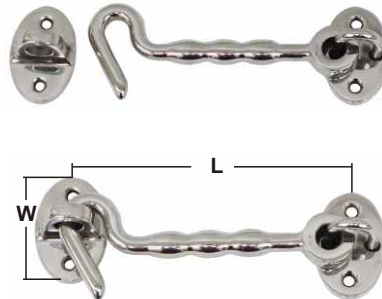

**CABIN HOOK** casted AISI 316

ITEM NO.	L mm	W mm	Weight/g
<b>B19-021</b>	96	37	90
<b>B19-022</b>	65	37	



**DOOR LOCK HOOK** casted AISI 316

with double swivel

ITEM NO.	L mm	Weight/g
<b>B19-033</b>	70(2-3/4")	64
<b>B19-045</b>	90(3-9/16")	71
<b>B19-046</b>	120(4-3/4")	77

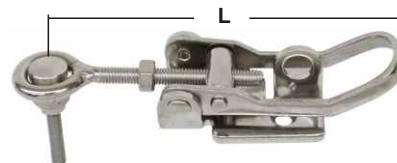

**ECCENTRIC LATCH** stamped AISI 304

ITEM NO.	adjustable L mm	Weight/g
<b>B19-035</b>	109 ~ 114	110



**OVAL GRAB RAILS** AISI 304

ITEM NO.	Length	Weight/g
<b>002271</b>	9"(23cm)	134
<b>002272</b>	12"(30cm)	179
<b>002273</b>	18"(46cm)	234
<b>002274</b>	24"(61cm)	329



**HANDLE** high polish AISI 316

ITEM NO.	L mm	H mm	Weight/g
<b>002228</b>	250	30	
<b>002229</b>	300	30	
<b>002230</b>	400	30	400
<b>002231</b>	500	30	
<b>002232</b>	600	30	
<b>002233</b>	700	30	

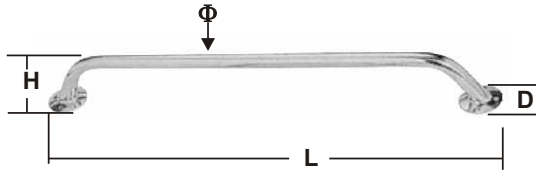

**HANDLE** AISI 304

ITEM NO.	L mm	H mm	D mm	Φmm
<b>002240</b>	400	75	51	20
<b>002260</b>	600	75	51	20

*on request AISI 316*

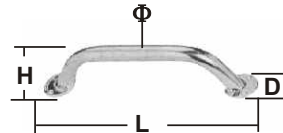

**HANDLE** AISI 304

ITEM NO.	L mm	H mm	D mm	Φmm
<b>002227</b>	270	65	40	20



**HANDRAIL** AISI 304

ITEM NO.	L mm	H mm	Weight
<b>002225</b>	300(12")	42	420g
<b>002226</b>	400(18")	42	514g

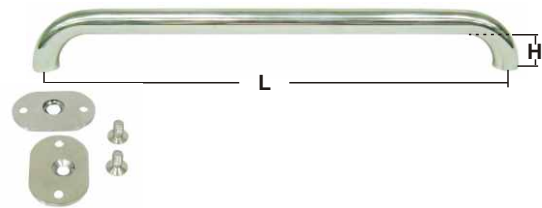

**HANDLE** high polish AISI 304  
Include mounting plate, screw

ITEM NO.	L mm	H mm
<b>002219</b>	300	40
<b>002220</b>	450	40



**PULL HANDLES** AISI 304  
solid stainless steel rod, satin finished, pull features a stylish look and easy grip design features ample hand clearance. Ideal for cabinets and drawers of all varieties. (Less screw)

ITEM NO.	L mm	Rod Dia mm	Thread	Weight/g
<b>002202</b>	76 (3")	10	M4	55
<b>002203</b>	90 (3-1/2")	10	M4	81
<b>002204</b>	102(4")	8	M4	

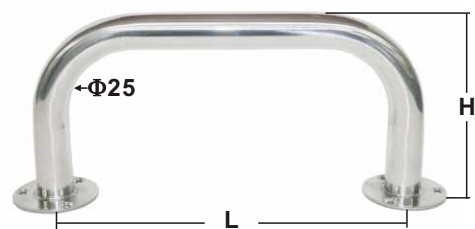

**HANDLE** AISI 316

ITEM NO.	L mm	H mm	Weight
<b>B16-006</b>	250	135	480g



**ANCHOR HOLDER** AISI 316  
Adjustable max 15kg

ITEM NO.	L mm	W mm	Weight
<b>073507</b>	540	150	3.0kg



**FENDER HOLDER** AISI 304

ITEM NO.		Weight
<b>007938</b>	Φ135mm for 125mm(5") double fenders	625g
<b>007939</b>	Φ160mm for 150mm(6") double fenders	730g
<b>007940</b>	Φ230mm for 200mm(8") double fenders	960g

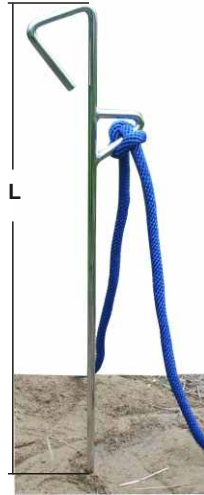

**SAND SPIKES**

An alternative to more expensive beach and land anchoring devices, this rod securely holds watercraft up to 26 feet (8 meter). Simply push into the ground, or use a hammer in firmer soils, and attach an anchor line to the attachment loop.

ITEM NO.	L cm	Material
<b>020321</b>	86	Steel chrome
<b>020322</b>	86	AISI 304



**FLAG POLE 45°** AISI 316

Staffs come completely with stainless steel the pole of sockets is 60cm(23-1/2")

ITEM NO.	Base	Weight
<b>009815</b>	98mm x 28mm	422g



**FLAG POLE 10°** AISI 316

staffs come complete with stainless steel socket, the pole is 43cm(17")

ITEM NO.	Base	Weight
<b>009636</b>	98mm x 28mm	280g

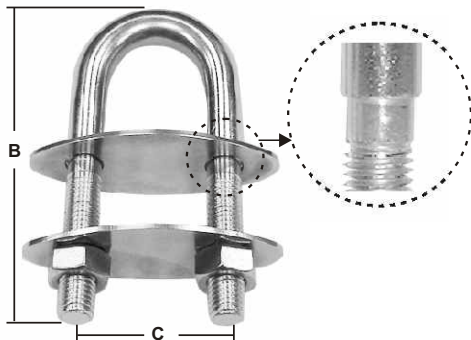

**U BOLTS** AISI 316

With oval plate

ITEM NO.	Thread	B mm	C mm	Weight/g
<b>005747</b>	M12	120	47	340

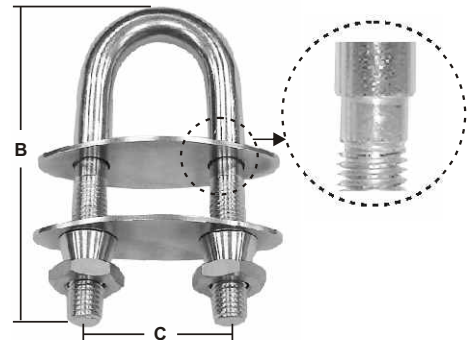

**SECURITY U BOLTS** AISI 316

With oval plate

ITEM NO.	Thread	B mm	C mm	Weight/g
<b>005750</b>	M12	120	47	350



**U BOLTS WITH NYLON LOCK NUTS** AISI 316

ITEM NO.	Thread	B mm	C mm	Weight/g
<b>005757</b>	M12	120	47	360



**FAIRLEADS** AISI 316

With oval plate

ITEM NO.	Thread	B mm	C mm	Fixing mm	Weight/g
<b>005733</b>	M6	80	35	6	81

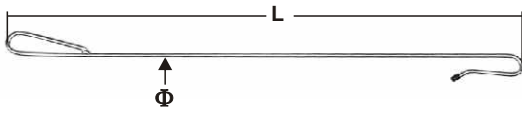

**BUOY AND LOCK HOOK** AISI 304  
 ITEM NO.  $\Phi$ mm L cm Weight/g  
**020319** 10 95



**STRONG BUOY HOOK** AISI 304  
 A very strong hook keeps your boat safe on the mooring bouy, easy to pick and release the bouy.  
 ITEM NO. Length Weight/g  
**020320** 120cm



**HOLDER FOR RESCUE DEVICE** AISI 304  
 fit  $\Phi$ 25mm tube rail  
 ITEM NO. Size Weight/g  
**007936** 105mmx65mm 420



**HOLDER FOR RESCUE DEVICE** AISI 304  
 fit  $\Phi$ 25mm tube rail  
 ITEM NO. Size Weight/g  
**007941**  $\Phi$ 95mmx300mm 440

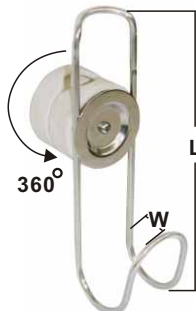

**HOOK** AISI 304  
 fit  $\Phi$ 25mm tube rail  
 ITEM NO. L mm W mm Weight/g  
**003017** 200 50 220



**DECK FILLER (WASTE)** casted AISI 316  
 According ISO 8099  
 ITEM NO. Dia mm O.D. mm Weight  
**008858** 38(1-1/2") 85(3-5/16") 470g



**WASTE** according ISO8099:200 AISI 316  
 ITEM NO. Weight  
**B16-002** 760g



**DECK FILLER** casted AISI 316  
fit for winch handle to close & open.

ITEM NO.	Dia mm	Type	Weight
<b>008887</b>	50(2")	FUEL	680g
<b>008888</b>	50(2")	WATER	680g
<b>008889</b>	50(2")	WASTE	680g
<b>004502</b>	key for deck filler		

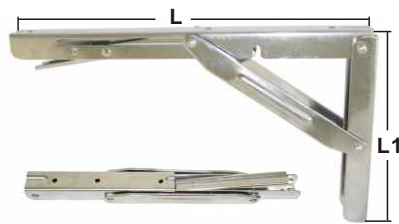

**FOLDING BRACKET** stamped AISI 304  
For tales and working plates, Load up to 150kg

ITEM NO.	L	L1	Weight/g
<b>006133</b>	303mm(12")	165mm(6-1/2")	530

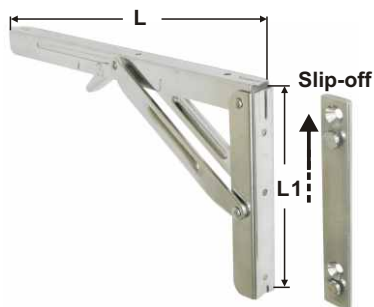

**SLIP-OFF FOLDABLE ARMS** stamped AISI 304  
For table can be slipped off their wall support.

Load up to 150kg

ITEM NO.	L	L1	Weight/g
<b>006135</b>	303mm(12")	165mm(6-1/2")	650

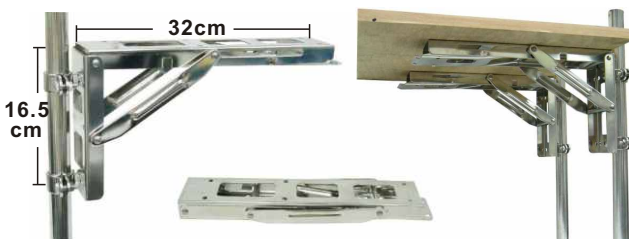

**BRACKET ASSEMBLY** stainless steel  
Folding bracket for table and working plates.  
Very stable, load up to 150kg. the set consists of 2 brackets, 4 clips (22-25mm tube) and 4 screw with nuts.

ITEM NO. **006131**



**LOW-PROFILE ANTENNA RATCHET MOUNTS WITH HANDLE** casted AISI 316  
installation on rails of 7/8"(22mm) and 1"(25mm).

ITEM NO.	Thread	Weight/g
<b>009693</b>	1"~14"	600



**LOW-PROFILE ANTENNA RATCHET MOUNTS** casted AISI 316  
no handle installation on rails of 7/8"(22mm) and 1"(25mm).

ITEM NO.	Thread	Weight/g
<b>009692</b>	1"~14"	450

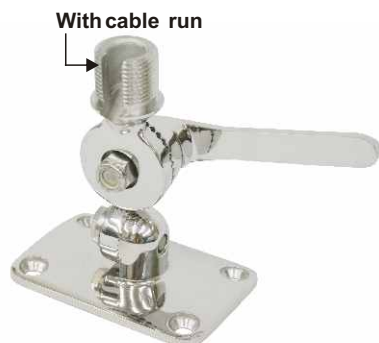

**ANTENNA RATCHET MOUNTS** casted AISI 316  
Socket 4-way ratchet design for mounting versatility.  
With cable run.

ITEM NO.	Base	Thread	Weight
<b>009896</b>	2-1/4"x3-1/2"	1"-14	640g economic

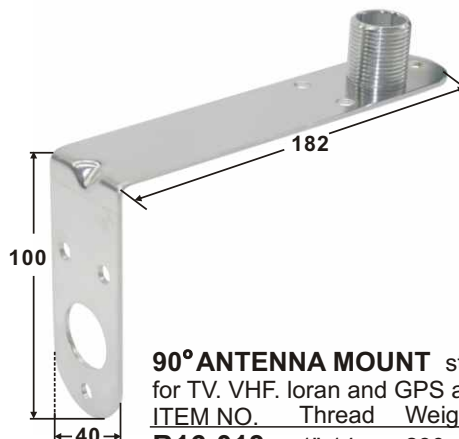

**90° ANTENNA MOUNT** stamped AISI 304  
for TV. VHF. Ioran and GPS antennas

ITEM NO.	Thread	Weight
<b>B16-013</b>	1"-14	230g

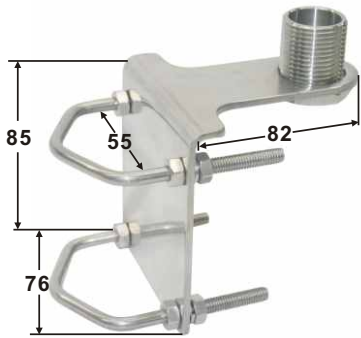

**90° ANTENNA MOUNT** stamped AISI 304  
for TV, VHF, Ioran and GPS antennas  
ITEM NO. Thread fit Tube Maximum  
**B16-011** 1"-14  $\Phi$ 55mm



**ECONOMY RAIL MOUNT** stamped AISI 304  
Fit 22mm(7/8") or 25mm(1")  
rails can also be mounted  
ITEM NO. Thread Weight/g  
**009689** 1"-14 140



**UNIVERSAL MOUNT** AISI 316  
For GPS/UKW antenna Height: 100mm(4")  
ITEM NO. Thread Weight/g  
**009871** 1"-14 300



**LIFT HANDLE LATCH** casted AISI 316  
Highly-polished  
ITEM NO. Base mm Weight/g  
**007109**  $\Phi$  44(1-3/4") 110



**LIFT HANDLE WITH COVER** casted AISI 316  
ITEM NO. Weight  
**007179** 350g



**DECK FILLER 45°** casted AISI 316  
ITEM NO. Dia mm Type Weight  
**008930** 38(1-1/2") WASTE 470g  
**008931** 38(1-1/2") GAS 470g  
**008932** 38(1-1/2") DIESEL 470g  
**008933** 38(1-1/2") WATER 470g



**DECK FILLER 30°** casted AISI 316  
ITEM NO. Dia mm Type  
**B19-010** 38(1-1/2") waste  
**B19-011** 38(1-1/2") gas  
**B19-012** 38(1-1/2") diesel  
**B19-013** 38(1-1/2") water



**TUBE HOLDER** casted AISI 316  
ITEM NO. For tube  $\Phi$  L mm W mm H mm Weight  
**B19-019** 22 mm 58 46 29 160g  
**B19-020** 25 mm 61.5 46 33 180g



**60° AFT HANDRAIL FITTING**  
casted AISI 316  
ITEM NO. Tube O.D. Weight  
**009647** 22mm(7/8") 140g

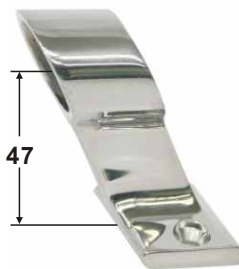

**120° FORWARD HANDRAIL FITTING** casted AISI 316  
ITEM NO. Tube O.D. Weight  
**009648** 22mm(7/8") 140g



**END STANCHIONS** Casted AISI 316  
With thread pin  
ITEM NO.  $\Phi$  L H Weight/g  
**009646** 36 70 86 293

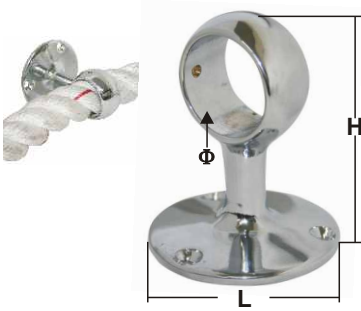

**CENTER STANCHIONS** Casted AISI 316

ITEM NO.	Φ	L	H	Weight/g
	mm	mm	mm	
<b>009645</b>	36	70	86	292



**90° ELBOW** casted AISI 316  
ITEM NO. Tube O.D. Weight  
**009686** 40mm(1-9/16")



**60° ROUND BASE** casted AISI 316  
ITEM NO. Tube O.D. Weight  
**009687** 40mm(1-9/16")



**60° UNIVERSAL TEE** casted AISI 316  
ITEM NO. Tube O.D. Weight  
**009684** 40mm(1-9/16")



**90° TEE SLEEVE** casted AISI 316  
ITEM NO. Tube O.D. Weight  
**009694** 40mm(1-9/16")



**RAIL FITTING WITH DISTANCE**  
Attachment 20x17mm AISI 316  
ITEM NO. Φmm  
**B18-022** 22  
**B18-023** 25

## NEW SIZE: 32mm SERIES



**90° ROUND BASE** casted AISI 316  
ITEM NO. Tube O.D. Base Weight/g  
**009609** 32mm(1-1/4") 75mm 260



**60° ROUND BASE** casted AISI 316  
ITEM NO. Tube O.D. Base Weight/g  
**009612** 32mm(1-1/4") 75mm 260



**60° RECTANGULAR BASE**  
casted AISI 316  
ITEM NO. Tube O.D. Base mm Weight/g  
**009617** 32mm(1-1/4") 82x42 250



**90° ELBOW** casted AISI 316  
ITEM NO. Tube O.D. Weight/g  
**009649** 32mm(1-1/4") 250



**60° UNIVERSAL TEE**  
casted AISI 316  
ITEM NO. Tube O.D. Weight/g  
**009669** 32mm(1-1/4") 300

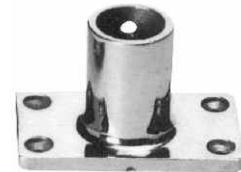

**90° RECTANGULAR BASE**  
casted AISI 316  
ITEM NO. Tube O.D. Base mm Weight/g  
**009678** 32mm(1-1/4") 82x42 250



**90° TEE** casted AISI 316  
ITEM NO. Tube O.D. Weight/g  
**009696** 32mm(1-1/4") 250



**SECURE CLIPS** AISI 316

For turnbuckle, packing 4pcs in one p.p bag

ITEM NO.	Turnbuckle	Weight/g (for 4pcs)
<b>008020</b>	for 5/16"	
<b>008021</b>	for 3/8"	
<b>008022</b>	for 7/16"	
<b>008023</b>	for 1/2"	
<b>008024</b>	for 5/8"	

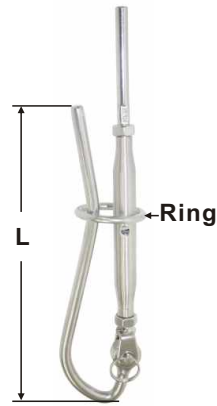

**FORESTAY TENSIONER WITH RING** AISI 304

Not include turnbuckle & swadge terminal

ITEM NO.	L mm	Ring $\phi$ mm (inside)	Wire $\phi$ mm
<b>004900</b>	115	30	6
<b>004901</b>	105	33	8
<b>004902</b>	220	40	10
<b>004903</b>	260	46	12

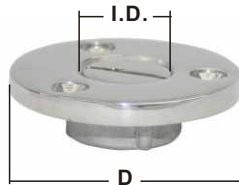

**GARBOARD DRAIN PLUG** casted AISI 316

ITEM NO.	I.D	D	Weight
<b>003781</b>	17mm	50mm(2")	90g

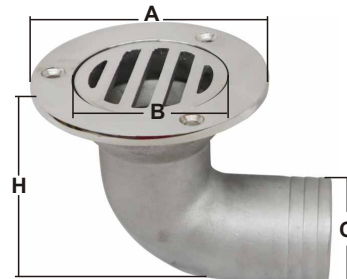

**SHOW / COCKPIT DRAINERS** stainless steel AISI 316

ITEM NO.	Flange $\phi$ (A)	Application hole (B)	Hose adaptor (C)	H mm	Weight/g
<b>B19-018</b>	80 mm	50 mm	38 mm	70	380



**FUEL TANK VENT ROUND HEAD** casted AISI 316

straight

ITEM NO.	Hose size	Weight/g
<b>003777</b>	35mm(1-3/8")	180



**FUEL TANK VENT ROUND HEAD** casted AISI 316

straight

ITEM NO.	Hose size	Weight/g
<b>003795</b>	19mm(5/8")	130



**PULL DRAIN PLUGS AND SLEEVES** AISI 316

With S.S. chain

ITEM NO.	Size	Weight
<b>009688</b>	25	50g



**GARBOARD DRAIN PLUG** casted AISI 316

Thread, removeable plug highly polished.

ITEM NO.	Hole mm	L mm	Weight/g
<b>003780</b>	27(1")	64(2-9/16")	110



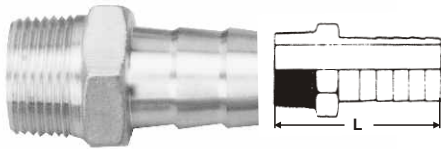

**HOSE NIPPLES (HONP)**

Threaded type: DIN 2999, NPT

ITEM NO.	SIZE	L	PACKING	MATERIAL
<b>300034</b>	3/4	72.86	150/Box	AISI 316
<b>300001</b>	1	82.46	80/Box	AISI 316

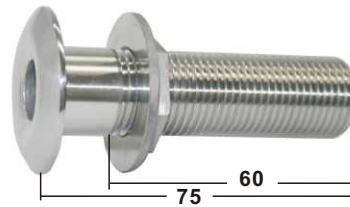

**SKIN FITTING** casted AISI 316

ITEM NO.	Size	Thread	Weight/g
<b>030012</b>	1/2"	BSP	140
<b>030034</b>	3/4"	BSP	



**90 DEGREE THRUHULL MUSHROOM HEAD BARBED** casted AISI 316

for use with hose, not for use below the waterline

ITEM NO.	Hose size	Max Thickness	Hull O.D. mm	Flange I.D. mm	Weight/g
<b>010006</b>	19mm	27 mm	43	33	162
<b>010007</b>	25mm	29 mm	43	33	183
<b>010008</b>	38mm	30 mm	59	34.5	393



**Y VALVE** casted AISI 316

2 way

ITEM NO.	Fit hose	Weight/g
<b>010018</b>	38mm(1-1/2")	1100



**SPRING CLAMPS** casted AISI 316

for boat hook

ITEM NO.	Min I.D.	Weight/g
<b>003116</b>	1"(25mm)	42



**MINI LOW FLAT CLEAT** with 2 holes AISI 316

ITEM NO.	Length mm	Inch	Weight
<b>003891</b>	80	3-3/16"	39g



**VENT** stamped AISI 304

ITEM NO.	L mm	W mm	Thickness	Weight
<b>B19-029</b>	100	100	1 mm	70g



**HOOK** Casted AISI 316

with rubber cord

Small tools for the practical suspension of ropes

ITEM NO.	Length	Weight/g
<b>003014</b>	72mm	63



**BUTTERFLY VENT** stamped AISI 304

ITEM NO.	Φ mm
<b>003740</b>	150(6")



**ROUND TRANSOM VENT** stamped AISI 304

ITEM NO.	O.D. mm	Weight/g
<b>003743</b>	150(6")	140
<b>003744</b>	150(6")	back with S.S. net 150
<b>003750</b>	65(2-9/16")	15
<b>003752</b>	65(2-9/16")	back with S.S. net 17



**VENT WITH THREAD** casted AISI 316  
Heavy duty  
ITEM NO. Lmm x Wmm Thread Weight/g  
**003797** 83 x84 M6 240



**COVER AISI 304**  
For ventilation it fit to item no.003727,  
003703,003706(less ventilation)  
ITEM NO. L mm H mm Weight/g  
**003775** 125 125 63



NiMH accumulator

**LOW PROFILE SOLAR VENTS WITH NIMH BATTERY** stainless steel cover, stamped AISI 304  
It needs rain or shine whether you're on the boat or not. solar cells power the fans for efficient, active venetilation. Low profile.  
Single crystal solar cells recharge NiMH battery for 24 hours operation.  
ITEM NO. Basement Weight/g  
**003794** 215mm(8-1/2") 800



**VENT AISI 304**  
ITEM NO. LxWxHmm Type Weight/g  
**003751** 95x88x24 midget 50



**UNIVERSAL STRAP**  
Stainless steel buckle, polyester webbing  
25mm wide Length:200cm  
ITEM NO. Weight/g  
**003566** 70



**DECK THROUGH AISI 304**  
Save and dry way to lead the electronic through the deck. Hole dimension  $\Phi$ 25mm  
ITEM NO. Weight/g  
**003742** 520



**FISHING ROD HOLDER** casted AISI 316  
Adjustable from 22mm(7/8") up to 30mm  
(1-3/16") round rails.

ITEM NO.	Length	I.D.	Weight/g
<b>009644</b>	250mm(10")	50mm(2")	1305

Adjustable 22~30mm



**CLAMP ON ROD HOLDER** casted AISI 316  
Adjustable for 7/8" or 1" round rails  
mountable on vertical or horizontal rails.  
with plastic knob screw.

ITEM NO.	Length	I.D.	Weight/g
<b>009667</b>	9"	1-1/2"	560



**CLAMP ON ROD HOLDER** casted AISI 316  
Adjustable up to 32mm round rail tube  
mountable on vertical or horizontal rails

ITEM NO.	Length	I.D.	O.D.
	mm	mm	mm
<b>009666</b>	245(9-5/8")	40(1-1/2")	65(2-1/2")

Can fit rail tube  $\Phi$ 25mm up to  $\Phi$ 32mm



**CLAMP ON ROD HOLDER** casted AISI 316  
Adjustable up to 32mm round rail tube  
mountable on vertical or horizontal rails

ITEM NO.	Length	I.D.	Weight/g
<b>009697</b>	9"	42mm	610

Can fit up to rail tube  $\Phi$ 32mm

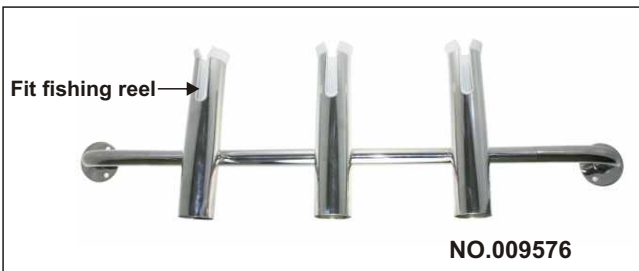

Fit fishing reel

NO.009576



NO.009570

**SMART ROD HOLDER SYSTEM** AISI 304

You can set up the rod holder according your demand any Qty any angle.

Rod holder I.D.:40mm. Can fit fishing reel.

Patent pending.

ITEM NO.	Description	L mm	Weight/g
<b>009570</b>	rod holder mounting	175	630
<b>009576</b>	rod holder triple + mounting	920	2130



**ROD HOLDER HANGER SET** casted AISI 316

ITEM NO.	Weight
<b>009665</b>	320g

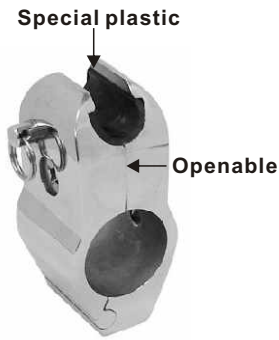

**OPENABLE JAW SLIDE** casted AISI 316  
special plastic inserts ensure smooth movement & tight rattle free fit. Include pin. Base for top cap with ball end.

ITEM NO.	Tube O.D.	Weight/g
<b>009690</b>	25mm(1")	260



**FLAT BASE** casted AISI 316  
special plastic inserts ensure smooth movement & tight rattle free fit. Include pin & lanyards. Base for top cap with ball end.

ITEM NO.	Base mm	Weight/g
<b>009691</b>	93x40	161



**QUICK RELEASE BIMINI** casted AISI 316

Adjustable angle

ITEM NO.	L mm	Weight/g
<b>009631</b>	90	150



**QUICK RELEASE FOR WEBBING** casted AISI 316

Adjustable angle

ITEM NO.	L mm	W mm	Weight/g
<b>009634</b>	90	25(1")	180
<b>009639</b>	90	30(1-1/6")	180



**QUICK RELEASE UNIVERSAL DECK HINGE** casted AISI 316

Adjustable angle

ITEM NO.	L mm	Weight/g
<b>009629</b>	90	165

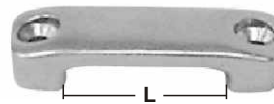

**FOOTMAN LOOPS FOR STRAPS**

Casted AISI 316

ITEM NO.	L mm	Weight/g
<b>008428</b>	28.5	31
<b>008429</b>	30	31
<b>008431</b>	40	40



**CARBINE HOOK** AISI 316

ITEM NO.	L mm	W mm	Weight/g
<b>000407</b>	50(2")	25(1")	25



**SNAP HOOK WITH BUCKLE** AISI 316

ITEM NO.	L mm	W mm	Weight/g
<b>000409</b>	70(2-3/4")	25(1")	43

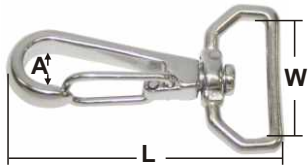

**WEB SWIVEL SNAP HOOK** Casted AISI 316  
 ITEM NO. Amm Lmm Wmm Weight/g  
**000411** 9 65 28 30

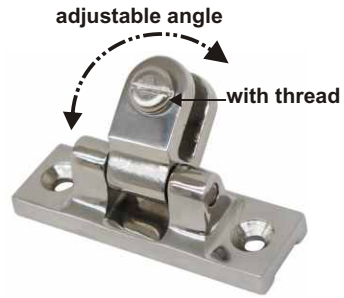

**UNIVERSAL DECK HINGE** casted AISI 316  
 ITEM NO. Base Weight/g  
**B19-009** 62x21mm(2-5/8"x1-1/8") 100

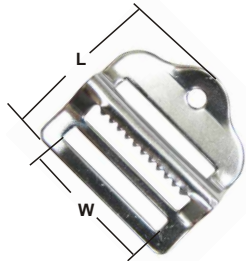

**BUCKLE** AISI 316  
 ITEM NO. L mm W mm Weight/g  
**004323** 34(1-5/16") 25(1") 10



**GRAB HANDLE CONNECTION**  
 stamped AISI 316  
 ITEM NO. L mm D mm Weight/g  
**009656** 90(3-1/2") 22(7/8")  
**009664** 90(3-1/2") 25(1")



**TOP CAP DECK FITTING FOR WINCH**  
 casted AISI 316  
 ITEM NO. **B18-002**



**FIXING PLATE WITH QUICK RELEASE** casted AISI 316  
 Disengage turning the central part.  
 ITEM NO. Base mm Tube O.D. Weight/g  
**009640** 89x32 22mm(7/8") 320  
**009641** 89x32 25mm(1") 250  
**009642** 89x32 30mm(1-3/16") 300



**CHAIN STOPPER** casted AISI 316  
 For chain 1/4"(6mm) to 5/16"(8mm) removable  
 pawl flips up when not in use  
 ITEM NO. Base measure mm Width/g  
**000117** 2-1/4"(58)x2-1/8"(54)x1-13/16"(47)H 300



**ANCHOR LOCK** AISI 316  
 Channel lock secures anchors  
 against accidental deployment.  
 Dia 6mm locking pin locks shackle  
 or chain to 10mm in place.  
 ITEM NO. L mm W mm H mm  
**000141** 100 35 35



**CHAIN CLAW** casted AISI 316  
 ITEM NO. Chain mm Weight/g  
**002303** 6~8 280



**STERN ANCHOR ROLLER** AISI 304  
mounting for  $\Phi$ 22mm & 25mm rail tube with belt

ITEM NO.	$\Phi$	Length	Width	Weight
<b>003690</b>	34cm	30m	50mm	5.1kg
<b>003691</b>	38cm	50m	50mm	

The nylon webbing can be replaced by yourself

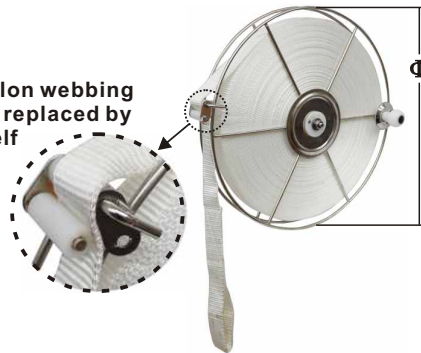

**STERN ANCHOR ROLLER** AISI 304  
mounting for  $\Phi$ 22mm & 25mm rail tube with belt

ITEM NO.	$\Phi$	Length	Width	Weight
<b>B19-040</b>	34cm	30m	50mm	5.1kg

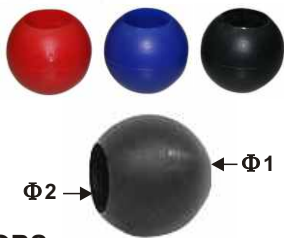

**STOPPER KNOBS**

Nylon plastic  
ITEM NO.

ITEM NO.	$\Phi$ 1 mm	$\Phi$ 2 mm	Color	Weight/g
<b>072406-1</b>	6	12.5	red	4
<b>072406-2</b>	6	12.5	blue	4
<b>072406-4</b>	6	12.5	black	4



**SINGLE STEP LADDER** AISI 316

With non-slip plastic cover and 4 pcs plastic plates which can be adjusted to different degree.

2 PCS for both sides will be 20°		
4 PCS for both sides will be 40°		
ITEM NO.	Length	Weight
<b>000738</b>	30 cm	580g



**3 STEPS TELESCOP WITH GRAB HANDLES** AISI 316

Mounting on the plat form with grab handles for easy entry.

ITEM NO.	Length Deployed	Length stowed	Height	Width
<b>000739</b>	34" (86cm)	14.5" (37cm)	15" (38cm)	12.5" (32cm)



**PLAT FORM TELESCOPING 3 DROP LADDER** AISI 316

ITEM NO.	Length Deployed	Length stowed	Height	Width	Bracket Length	Weight
<b>000736</b>	34" (86cm)	16" (41cm)	16" (41cm)	12.5" (32cm)	5cm	3.5kg



**3 STEP TELESCOPE BOW LADDER** AISI 316

For a range of Bruce/M-Anchor from 7,5kg up to 20kg  
Easy adjustable for any size from 7,5kg up to 20kg.

ITEM NO.	Weight/g
<b>000737</b>	3775



**FOLDING CLEATS** casted AISI 316

Folding cleats with recessed screw do not require a cutout.

ITEM NO.	Length mm	Weight
<b>003876</b>	85(4-3/8")	210g



**FOLDING CLEATS** casted AISI 316

Folding cleats with recessed screw do not require a cutout.

ITEM NO.	Length mm	Weight
<b>003892</b>	120(4-3/4")	200g
<b>003889</b>	155(6-1/8")	500g



**FOLDING CLEATS WITH THREAD** casted AISI 316

ITEM NO.	Length mm	Thread
<b>B19-004</b>	120(4-3/4")	M10
<b>B19-005</b>	155(6-1/8")	M10



**PULL OUT CLEATS** casted AISI 316

ITEM NO.	Length mm	Thread	Weight
<b>B19-006</b>	150(6")	M10	490g
<b>B19-007</b>	200(8")	M10	



**PULL OUT CLEATS** casted AISI 316  
With stainless steel counter plate and thread

ITEM NO.	Length mm	Thread
<b>B19-015</b>	150(6")	M10
<b>B19-016</b>	200(8")	M10

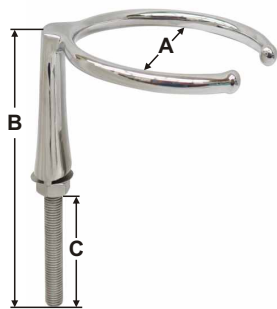

**CUP AND BOTTLE HOLDER** AISI 316

ITEM NO.	A mm	B mm	C mm	Model	Width/g
<b>B19-001</b>	88	150	80	single	310

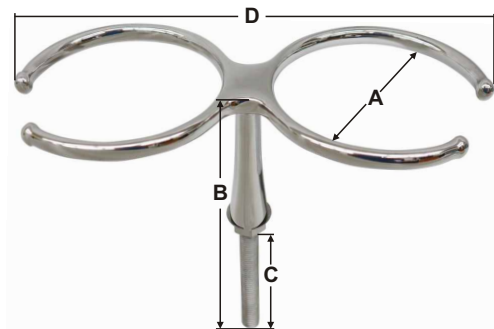

**CUP AND BOTTLE HOLDER** AISI 316

ITEM NO.	A mm	B mm	C mm	D mm	Model	Width/g
<b>B19-002</b>	88	150	80	210	double	420



**STAINLESS STEEL DRINK HOLDER**

Gimbaled caddy holds beverage cans, bottles and glasses level. Includes insulated cozy and clip for flat surface mounting.

ITEM NO.	Box
<b>007798</b>	50

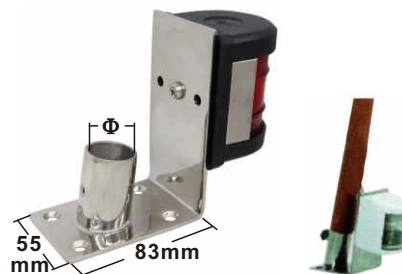

**FLAG AND NAVIGATION LIGHT**

**SOCKETS** AISI 304 (Less navigation light)

ITEM NO.	Φmm	Weight
<b>B18-018</b>	25	190g

## OPTIMIST COLLECTION

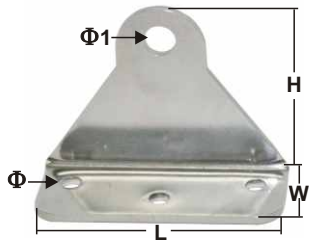

### PLATE FITTING FOR RUDDER OPTIMIST

stamped AISI 304

ITEM NO.	L	W	H	Φ	Φ1	Weight/g
	mm	mm	mm	mm	mm	
<b>008741</b>	50	21	38	4.1	6.1	30



### PLATE FOR OPTIMIST stamped AISI 304

ITEM NO.	L	W	Φ	Weight/g
	mm	mm	mm	
<b>008751</b>	50	20	5.5	10

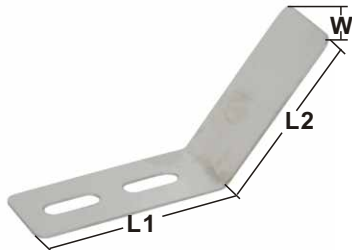

### SPRING PLATE FOR OPTIMIST stamped AISI 304

ITEM NO.	L1	L2	W	Weight/g
	mm	mm	mm	
<b>008761</b>	42	38	19	10

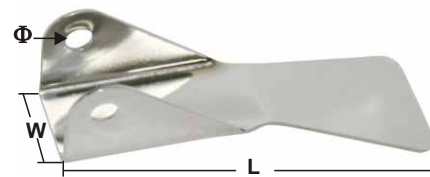

### FITTING FOR OPTIMIST stamped AISI 304

ITEM NO.	L	W	Φ	Weight/g
	mm	mm	mm	
<b>008762</b>	62	24.5	4.5	10

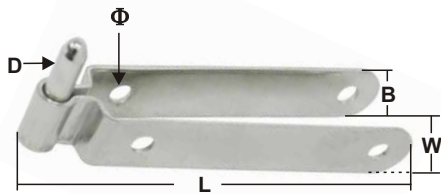

### RUDDER FITTING FOR OPTIMIST

stamped AISI 304

ITEM NO.	L	B	D	W	Φ	Weight/g
	mm	mm	mm	mm	mm	
<b>008795</b>	95	15	6	13.1	5.1	40

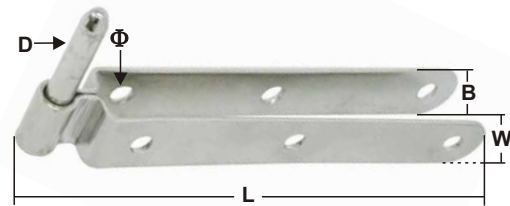

### RUDDER FITTING FOR OPTIMIST

stamped AISI 304

ITEM NO.	L	B	D	W	Φ	Weight/g
	mm	mm	mm	mm	mm	
<b>008796</b>	120	15	6	13.1	5.1	50

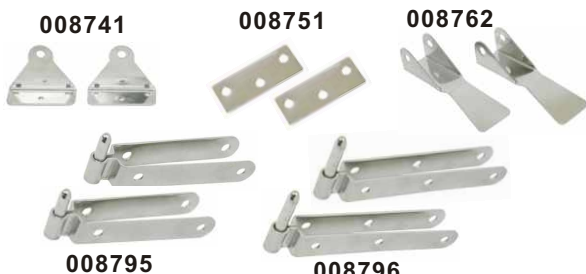

### RUDDER FITTING SET

Include 008741x2, 008751x2, 008762x2, 008795x2, 008796x2

ITEM NO.	Weight/g
<b>008700</b>	280



### ADJUSTABLE MAST STEP AISI 304

Round type with stainless steel spring which prevents the nut from turning accidentally

ITEM NO.	Weight/g
<b>008702</b>	310



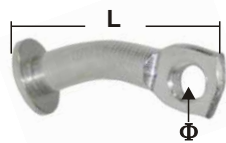

**CURVED PIN FOR OPTIMIST**

AISI 304

ITEM NO.	L	Φ	Weight/g
	mm	mm	
<b>008704</b>	35	5	10

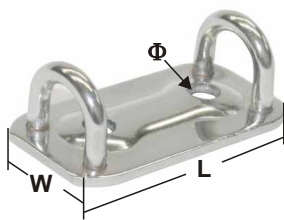

**DECK PLATE FOR OPTIMIST**

Stamped AISI 304

ITEM NO.	L	W	Φ	Weight/g
	mm	mm	mm	
<b>008705</b>	50	26	5.5	20

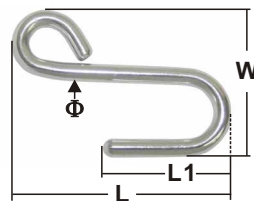

**S HOOK** AISI 304

ITEM NO.	Φ	L	L1	W	Weight/g
	mm	mm	mm	mm	
<b>004026</b>	5	60	34	38	20



**TILLER CLAMP**

Stamped AISI 304

ITEM NO.	L	Weight/g
	mm	
<b>008763</b>	78	50



**SWIVEL FOR OPTIMIST**

AISI 304

ITEM NO.	L	W	Weight/g
	mm	mm	
<b>008764</b>	40	12	20



**RAILING LEAD** AISI 304

ITEM NO.	L	Weight/g
	mm	
<b>008765</b>	70	45



**TRAPEZE RING WITH BAR**

AISI 304

ITEM NO.	L	B	Weight/g
	mm	mm	
<b>004634</b>	200	35	72

*on request AISI 316*



**MAST CLIP** AISI 304

For optimist boat  
stainless steel clip  
covered with neoprene

ITEM NO.	Weight/g
<b>008701</b>	50

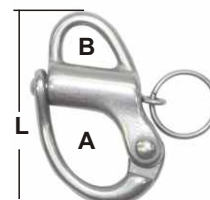

**MINI FIXED SNAP** AISI 316

ITEM NO.	A	B	L	Weight/g
	mm	mm	mm	
<b>001511</b>	10	7	32	10



**TRIGGER SNAP WITH SWIVEL EYE** AISI 316

ITEM NO.	L	L1	D
	mm	mm	mm
<b>B19-034</b>	46	12	14



**DOG BONE** AISI 304

ITEM NO.	L	Φ	Weight/g
	mm	mm	
<b>B17-008</b>	153	31	45

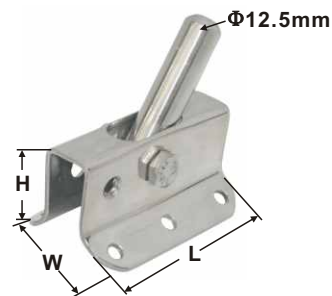

**MAST FITTING**

Stamped AISI 304

ITEM NO.	L	H	W	Weight/g
	mm	mm	mm	
<b>B17-009</b>	65	35	42	140

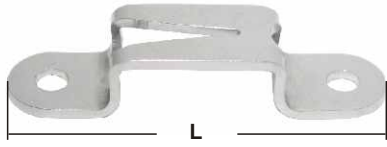

**V CLEAT** AISI 304  
 For school masts and booms  

ITEM NO.	L mm
<b>008703</b>	50

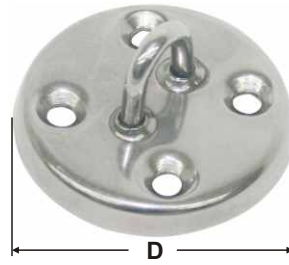

**SWIVEL BASE** stamped AISI 304  

ITEM NO.	Dmm	Weight/g
<b>005061</b>	55	40



**SWIVEL BASE** stamped AISI 304  

ITEM NO.	L mm	W mm	Weight/g
<b>005063</b>	50	26	

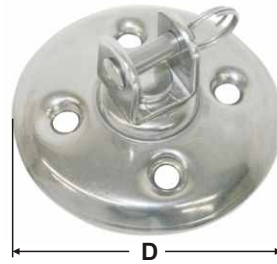

**SWIVEL BASE** stamped AISI 304  

ITEM NO.	D mm	Weight/g
<b>005062</b>	58(2-1/4")	50

ITEM NO.	PAGE	ITEM NO.	PAGE	ITEM NO.	PAGE	ITEM NO.	PAGE
000117	A23	002271	A12	003781	A18	007941	A14
000141	A23	002272	A12	003794	A20	008020	A18
000317	A7	002273	A12	003795	A18	008021	A18
000318	A7	002274	A12	003797	A20	008022	A18
000319	A7	002303	A23	003871	A1	008023	A18
000407	A22	003014	A19	003874	A1	008024	A18
000409	A22	003017	A14	003876	A24	008311	A7
000411	A23	003116	A19	003889	A25	008319	A7
000736	A24	003129	A11	003891	A19	008340	A8
000737	A24	003406	A7	003892	A25	008348	A8
000738	A24	003408	A7	004026	A27	008399	A7
000739	A24	003410	A7	004323	A23	008428	A22
001306-P	A7	003566	A20	004502	A15	008429	A22
001308-P	A7	003590	A10	004634	A27	008431	A22
001310-P	A7	003591	A10	004900	A18	008511	A8
001511	A27	003592	A10	004901	A18	008512	A8
001800	A7	003597	A10	004902	A18	008513	A9
001801	A7	003598	A10	004903	A18	008514	A9
001802	A7	003599	A10	005061	A28	008515	A8
001803	A7	003684	A11	005062	A28	008516	A9
001816	A7	003687	A11	005063	A28	008614	A8
001817	A7	003688	A11	005733	A13	008700	A26
001818	A7	003690	A24	005747	A13	008701	A27
001819	A7	003691	A24	005750	A13	008702	A26
002202	A12	003692	A10	005757	A13	008703	A28
002203	A12	003693	A10	006131	A15	008704	A27
002204	A12	003695	A10	006132	A9	008705	A27
002219	A12	003696	A10	006133	A15	008741	A26
002220	A12	003697	A10	006134	A9	008751	A26
002225	A12	003698	A11	006135	A15	008761	A26
002226	A12	003740	A19	006137	A8	008762	A26
002227	A12	003742	A20	006138	A8	008763	A27
002228	A12	003743	A19	006139	A8	008764	A27
002229	A12	003744	A19	007109	A16	008765	A27
002230	A12	003750	A19	007179	A16	008795	A26
002231	A12	003751	A20	007798	A25	008796	A26
002232	A12	003752	A19	007936	A14	008858	A14
002233	A12	003775	A20	007938	A13	008887	A15
002240	A12	003777	A18	007939	A13	008888	A15
002260	A12	003780	A18	007940	A13	008889	A15

ITEM NO.	PAGE	ITEM NO.	PAGE	ITEM NO.	PAGE	ITEM NO.	PAGE
008893	A1	009692	A15	B19-002	A25	B22-011	A6
008894	A1	009693	A15	B19-004	A25	B22-019	A3
008895	A1	009694	A17	B19-005	A25	B23-002	A3
008930	A16	009696	A17	B19-006	A25	B23-003	A3
008931	A16	009697	A21	B19-007	A25	B23-004	A3
008932	A16	009815	A13	B19-009	A23	B23-005	A3
008933	A16	009871	A16	B19-010	A16	B23-006	A3
009570	A21	009896	A15	B19-011	A16	B23-007	A3
009576	A21	010006	A19	B19-012	A16	B23-008	A4
009609	A17	010007	A19	B19-013	A16	B23-009	A2
009612	A17	010008	A19	B19-015	A25	B23-010	A5
009617	A17	010018	A19	B19-016	A25	B23-011	A5
009629	A22	020319	A14	B19-017	A11	B23-012	A4
009631	A22	020320	A14	B19-018	A18	B23-013	A4
009634	A22	020321	A13	B19-019	A16	B23-014	A4
009636	A13	020322	A13	B19-020	A16	B23-020	A5
009639	A22	030012	A19	B19-021	A11	B23-021	A5
009640	A23	030034	A19	B19-022	A11	B23-022	A5
009641	A23	072406-1	A24	B19-024	A10	B23-023	A5
009642	A23	072406-2	A24	B19-025	A10	B23-024	A5
009644	A21	072406-4	A24	B19-026	A10	B23-025	A2
009645	A17	073507	A12	B19-027	A9	B23-026	A2
009646	A16	2431-SS	A2	B19-028	A8	B23-027	A4
009647	A16	300001	A19	B19-029	A19	B23-029	A2
009648	A16	300034	A19	B19-030	A9	B23-030	A2
009649	A17	B16-002	A14	B19-033	A11	B23-031	A2
009656	A23	B16-006	A12	B19-034	A27	B23-032	A4
009664	A23	B16-011	A16	B19-035	A11	B23-034	A4
009665	A21	B16-013	A15	B19-039	A10	B23-035	A3
009666	A21	B17-002	N1	B19-040	A24	B23-036	A1
009667	A21	B17-008	A27	B19-045	A11	B23-041	A4
009669	A17	B17-009	A27	B19-046	A11	B23-045	A4
009678	A17	B18-002	A23	B22-001	A2	B23-048	A1
009684	A17	B18-013	A10	B22-004	A3	B23-049	A1
009686	A17	B18-015L	A9	B22-005	A6	B23-050	A1
009687	A17	B18-015R	A9	B22-006	A6	B23-051	A1
009688	A18	B18-018	A25	B22-007	A6	B23-052	A1
009689	A16	B18-022	A17	B22-008	A6	B23-053	A1
009690	A22	B18-023	A17	B22-009	A6	B23-054	A1
009691	A22	B19-001	A25	B22-010	A6	B23-055	A4

ITEM NO.	PAGE
B24-001	N1
B24-002	N3
B24-003	N1
B24-004	N3
B24-005	N2
B24-006	N1
B24-008	N2
B24-009	N2
B24-010	N3
B24-011	N3
B24-012	N3
B24-013	N1
B24-016	N2
B24-017	N2
B24-018	N2
B24-019	N2
B24-020	N1
B24-022	N1
B24-023	N3
B24-024	N3
B24-026	N3
B24-027	N4
B24-028	N2
B24-029	N2
B24-030	N4
B24-031	N4
B24-032	N4
B24-037	N5
B24-038	N5
B24-039	N5
B24-040	N5